

## Wiring

Having correctly identified the wiring from your existing light fitting, pull the mains wire through the hole and connect to the quick fit connection block in the following way.

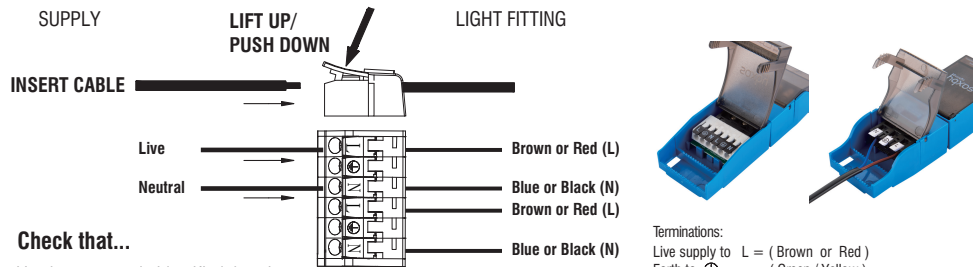

Terminations:  
Live supply to L = ( Brown or Red )  
Earth to ⊕ = ( Green / Yellow )  
Neutral to N = ( Blue or Black )  
The terminal block allows for Loop-in / Loop-out connection.

### Check that...

You have correctly identified the wires.

The connections are tight.

No loose strands have been left out of the connection block.

## Technical data

Supply Voltage: 220-240 V~, 50 Hz | Bulb Type: 5/7W LED (SMD) 4CCT, 2700/3000/4000/6000K  
This product contains a light source of energy efficiency class **E**.

  Non-replaceable light source

 Non-replaceable control gear

 Conformity with all relevant UKCA Directive requirements.

 Conformity with all relevant EC Directive requirements.

 The power supply is Double Insulated and does not require connection to an Earth circuit.

 Waste electrical products should not be disposed of with household waste. Please recycle where facilities exist. Check with your Local Authority or local store for recycling advice.

 This product is suitable for dimming.

 This product is fire rated to 30, 60, 90 minutes.

 This product is rated at IP65.

## Care and Safety

We recommend cleaning with a soft dry cloth. Do not use solvents or abrasive cleaners as these could damage the finish.

For your safety, always switch off the power supply before cleaning.

For further information, please visit <https://www.lighting-info.co.uk/112551>

V1 27/08/2024

UK Manufacturer: BH17 7BY

EU Manufacturer: Brilliant AG,  
Brilliantstrasse 1, D-27442 Gnarrenburg

saxby  
lighting

Instruction manual

# ShieldPRO 4CCT Dual Wattage

112551, 113640



[www.saxbylighting.com](http://www.saxbylighting.com)

saxby  
lighting

Thank you for purchasing this light fitting. Please read the instructions carefully before use to ensure safe and satisfactory operation of this product. Please retain these instructions for future reference.

## Warning

 This light fitting is double insulated and does not require connection to an Earth circuit.

Please read these instructions carefully before commencing any work.

This unit must be fitted by a competent and qualified electrician.

Install in accordance with the IEE Wiring regulations and current Building Regulations.

Check the pack and make sure you have all the parts listed.

To prevent electrocution switch off at mains supply before installing or maintaining this fitting. Ensure other persons cannot restore the electrical supply without your knowledge. If you are in any doubt, please consult a qualified electrician.

This light fitting should be connected to a circuit with a 30mA RCD fitted.

This luminaire is suitable for use in ambient temperatures of  $-20^{\circ}\text{C}$  to  $+40^{\circ}\text{C}$ .

Waste electrical products should not be disposed of with household waste. Please recycle where facilities exist. Check with your local authority or retailer for recycling advice.

## Layout

Plan the desired layout of these fittings carefully, ensuring the cables will reach the distances between each light fitting.

Avoid locating any cables in positions that would cause a hazard. Position cables and junction boxes (not supplied) away from areas where they may be at risk from being cut, trapped or damaged.

The mains supply cable must have a minimum cross section area of  $1.0\text{mm}^2$ .

Cables must be protected using suitable conduit or plastic trunking.

When more than one downlight is installed, the minimum distance between units is 500mm. The unit must be located a minimum distance of 50mm from a joist.

This product must be mounted out of arms reach.

This product is suitable for use in zone 2 and outside zones of a bathroom. Please see diagram.

If this unit is being fitted in Zone 1 a room containing a bath or shower, a 30mA RCD must be used - in accordance with IEE regulations.

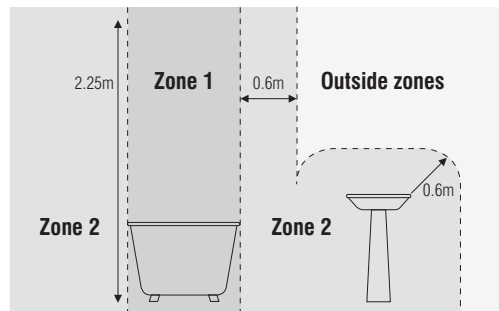

## Installation

Existing fittings must be completely removed before installation of a new product. Before removing the existing fitting, carefully note the position of each set of wires.

The ceiling surface must be flat and smooth to ensure a good fit.

Note that the switch is turned off before installation.

Ensure that the screws and cable entry points are sealed to maintain the IP rating of the product.

Follow the installation steps below to install.



### Watt Switch

The wattage is changeable between 5/7W using the Wattage Switch.

### CCT Switch

The colour is changeable between 2700/3000/4000/6000K using the CCT Switch.

Choose your preferred wattage or colour before installing by Wattage switch or CCT switch inside the lamp cup of the product.

**Note: Before you change the wattage or colour, please turn off the power switch for safety.**

