



Lia LED 600mm

Wall fixture Lia LED 600mm LED 23.1 LED warm-white 3000K ON-OFF Satin nickel 1635lm

Technical features

- Luminaire total power: 23.1W
- Real lumens: 1635
- Real lm/W: 71
- Correlated Colour Temperature (CCT): LED warm-white 3000K
- Lens / reflector angle: HORIZONTAL 136°
- Structure material: Steel
- Structure finish: Satin nickel
- Diffuser material: Polycarbonate
- Diffuser finish: Opal
- Voltage / frequency: 100-240V/50-60Hz
- Dimming protocol: ON-OFF
- Power Factor: 0.90
- Useful life: 50,000h L80B20
- Warranty: 5 años

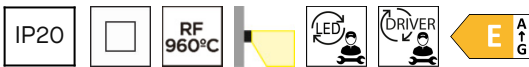

Luminotechnic features

- CRI: 80
- MacAdam steps: 3
- Photobiological risk: RGO
- UGR crosswise: 20.7
- UGR lengthwise: 15.2

Lampholder	Quantity	Light source power (W)
LED	1	20.8W

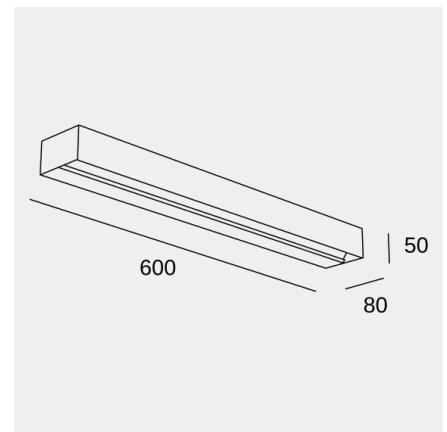

Image may not match reference. LedsC4 reserves the right to amend any of the product's components. The data related to flux, power and colour temperature may be subject to changes made by the manufacturer.



Lia LED 600mm

Wall fixture Lia LED 600mm LED 23.1 LED warm-white 3000K ON-OFF Satin nickel 1635lm

Logistics



x 6

Net weight (kg): 1.37

Packaged weight (kg): 1.99

Packaging: 660mm x 100mm x
130mm

Image may not match reference. LedsC4 reserves the right to amend any of the product's components. The data related to flux, power and colour temperature may be subject to changes made by the manufacturer.